

NEW POWERMONDIAL, STATE OF THE ART IN TRACTOR TECHNOLOGY

Designed for modern farmers and agricultural contractors who desire to perform a variety of light- and heavy-duty tasks with one machine, the new POWERMONDIAL series represents the state of the art in mid- to high-range farm tractors.

With a power-to-weight ratio of 45 Kg/hp, the POWERMONDIAL is designed to minimise soil compaction. All models are equipped with the new Perkins 1104D series turbo-aftercooled engines up to 112 HP which deliver exceptional power and torque while meeting the Tier 3 emission standards. The 120 model, in particular, features an electronic injection engine with Dual Power system which automatically delivers extra power and torque at the PTO when needed.

The range offers two versions – *Techno* and *Top* - featuring two different transmission models. The *Techno* version offers a 15-speed mechanical transmission (*Speed Five*) which can be combined with a creeper and mechanical reverse shuttle to achieve 20 forward and 20 reverse speeds.

The *Top* version features a 12-speed transmission (*Speed Four*) combined with a hydraulic *Three-Shift* option (*T Tronic*), which triples the gears of the basic transmission under load to 36 forward + 12reverse.

A creep transmission and a hydraulic power shuttle extend flexibility to 48 forward and 16 reverse speeds. The electrohydraulically-engaged PTO comes with a choice of two speeds - 540/750 or 540/1000 rpm. An optional 3-speed PTO (540/750/1000 rpm) is also available for maximum versatility. The front axle with 55-degree steering angle and electrohydraulic 4WD engagement is equipped with integrated wet disc brakes for positive braking on all four wheels.

The *Top* version features as standard an electronic Cat. 2 power lift with a maximum lift capacity of 4700 kg and up to five rear hydraulic remote valves. A front lift and PTO and a front loader are also available as an option to further extend the flexibility of the *POWERMONDIAL* range.

The four-post cab with full-sized, rear-hinged doors provides superb all-round visibility. With ergonomically-arranged controls, climate control and a sliding sunroof for loader operations the *Master Class* cab is built to provide the operator with superior comfort.



		POWERMONDIAL 110 TECHNO	TOP	POWERMONDIAL 115 TECHNO	TOP	POWERMONDIAL 120 DUAL POWER - TOP
ENGINE						
PERKINS DIRECT-INJECTION TURBO-AFTERCOOLED TIER 3 ENGINE		1104D-44TA		1104D-44TA		1104D-E44TA ELECTR.INIEZ.
MAX. POWER (ISO)	HP/KW	101,9/74,9		110,2/81		112/82
40KM/H "FUEL SAVE" - REDUCED ENGINE RPM	RPM	-		-		1830
ENGINE POWER WITH DUAL POWER FOR PTO (ISO RATING)	HP/KW	-		-		121/89
MAX. TORQUE	NM	412		410		466 (486)
DISPLACEMENT/NR. OF CYLINDERS	CM ³	4400/4		4400/4		4400/4
FUEL TANK CAPACITY	LTRS	180		180		180
CLUTCH						
SINGLE-PLATE DRY CLUTCH	INCH	13"(330)		13"(330)		-
MULTI-DISC WET CLUTCH		•		•		•
DECLUTCH CONTROL: BY BUTTON		•		•		•
TRASMISSIONE						
SPEED FIVE + MECH. REV. SHUTTLE: 15FWD+15REV		•		•		-
SPEED FIVE + CREEPER + MECH. REV. SHUTTLE: 20FWD+20REV		○		○		-
T-TRONIC + SPEED FOUR+ HYDR. REV. SHUTTLE: 36FWD+12REV (3 POWERSHIFT SPEEDS)		•		•		•
T-TRONIC + SPEED FOUR + CREEPER+ HYDR. REV. SHUTTLE: 48FWD+16REV		○		○		○
SHUTTLE MODULATION CONTROL: POTENTIOMETER FOR ADJUSTMENT OF POWER SHUTTLE AGGRESSIVENESS		-		-		•
REVERSE POWER SHUTTLE: POWER SHUTTLE UNDER LOAD		•		•		•
PARK LOCK		•		•		•
POWER TAKE-OFF						
WET MULTI-DISK HYDRA-PTO		•		•		•
ELECTROHYDRAULIC ENGAGEMENT		•		•		•
2 SPEEDS: 540/750 RPM		•		•		•
2 SPEEDS: 540/1000 RPM		○		○		○
3 SPEEDS: 540/750/1000 RPM		○		○		○
NET PTO POWER (ISO)	HP/KW	91,8/67,5		99/72,5		-
FRONT 4WD AXLE						
ELECTROHYDRAULIC 4WD ENGAGEMENT		•		•		•
MAX. STEERING ANGLE	DEGREES	55		55		55
TWIN-LOCK ELECTROHYDRAULIC DIFF-LOCKS		•		•		•
BRAKES						
WET REAR BRAKES - 10 DISCS		•		•		•
WET FRONT BRAKES - 4 DISCS		•		•		•
IBS INTEGRAL BRAKING SYSTEM		•		•		•
HYDRAULIC POWER LIFT						
MECHANICALLY CONTROLLED		•		•		-
ELECTRONICALLY-CONTROLLED LANDTRONIC POWER LIFT		•		•		•
ERGONOMIC LIFT SYSTEM + REAR LIFT CONTROL		○		○		-
LIFT CAPACITY WITH STD 55MM ASSISTOR RAMS	KG	4700 ○		4700 ○		4700 ○
HYDRAULIC PUMP FLOW (POWER LIFT + STEERING)	LT/MIN	52+29,9		52+29,9		60+29,9
REMOTE VALVES STANDARD / OPTIONAL		3 / 5		3 / 5		3 / 5
FRONT POWER LIFT AND PTO	MAX LIFT CAPACITY KG	2500 ○		2500 ○		2500 ○
CAB AND DRIVING POSITION						
"MASTER CLASS" CAB / RADIO ADAPTOR		•		•		•
AIR-CONDITIONING		•		•		-
CLIMATE CONTROL		•		•		•
DIMENSIONS AND WEIGHTS						
FRONT TYRES		440/65R24		440/65R24		440/65R24
REAR TYRES		540/65R34		540/65R34		540/65R34
A - LENGTH 4WD	MM	4400		4400		4400
B - WHEELBASE 4WD	MM	2400		2400		2400
C - MIN. WIDTH	MM	2056		2056		2056
D - HEIGHT OVER CAB	MM	2730		2720		2720
E - GROUND CLEARANCE	MM	420		420		420
WEIGHT IN RUNNING ORDER (WITHOUT BALLAST WEIGHTS)	KG	4200		4200		4200

Key: • standard ○ option - not available

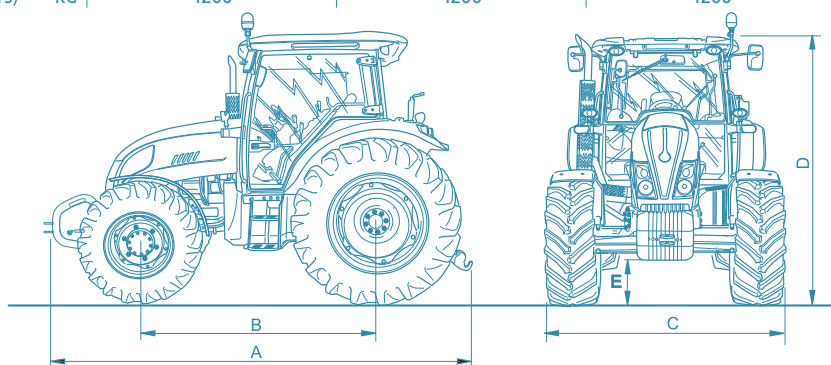

NEW

Powermondial

110 - 115 - 120



Landini®



Perkins

Diesel Power

TURBO NEW
AFTERCOOLER
TIER 3 • 4 cylinders

NEW PERKINS TIER 3 1104D SERIES ENGINES AND TILT-UP HOOD

THE NEW PERKINS 4-CYLINDER *TURBO-AFTERCOOLED* ENGINES DELIVER 102, 110 AND 112 HP (ISO). THEY COMPLY WITH THE TIER 3 EMISSION STANDARDS AND PROVIDE HIGH TORQUE BACKUP, IMPROVED FUEL ECONOMY AND LOW NOISE LEVELS.

THE 120 MODEL, IN PARTICULAR, FEATURES AN ELECTRONIC INJECTION ENGINE WITH DUAL POWER SYSTEM TO AUTOMATICALLY INCREASE THE POWER AND TORQUE AVAILABLE AT THE PTO.

THE TILT-UP HOOD PROVIDES EASY ACCESS TO THE ENGINE COMPARTMENT FOR ROUTINE SERVICE AND MAINTENANCE. > FIG. A



NEW FRONT AXLE

THE 4WD FRONT AXLE WITH ELECTROHYDRAULIC ENGAGEMENT AND 55-DEGREE STEERING ANGLE ENSURES OPTIMUM GROUND CLEARANCE AND EXCELLENT MANOEUVRABILITY.

THE COMBINED ACTION OF THE FRONT AND REAR WET DISC BRAKES ENSURES SAFE AND EFFECTIVE BRAKING ON ALL FOUR WHEELS. > FIG. B

T-TRONIC TRANSMISSION (48FWD+16REV) WITH DE-CLUTCH CONTROL AND REVERSE POWER SHUTTLE

THE *T-TRONIC* TRANSMISSION TRIPLES THE 12 GEARS OF THE BASIC TRANSMISSION (*SPEED FOUR*) UNDER LOAD, GIVING A TOTAL NUMBER OF 36 FORWARD SPEEDS PLUS 12 REVERSE SPEEDS THAT ARE ACHIEVED USING THE GREEN BUTTONS ON THE GEAR SHIFT LEVER. > FIG. C

A CREEP TRANSMISSION IS AVAILABLE AS AN OPTION, EXTENDING FLEXIBILITY TO 48 FORWARD AND 16 REVERSE SPEEDS.

THE *DE-CLUTCH CONTROL* (ORANGE BUTTON ON THE GEAR SHIFT LEVER) (FIG. C) AND THE REVERSE POWER SHUTTLE (LEVER FITTED UNDER THE STEERING WHEEL) (FIG. D) ALLOW THE OPERATOR TO CHANGE GEAR AND SHIFT FROM FORWARD TO REVERSE WITHOUT USING THE CLUTCH PEDAL.

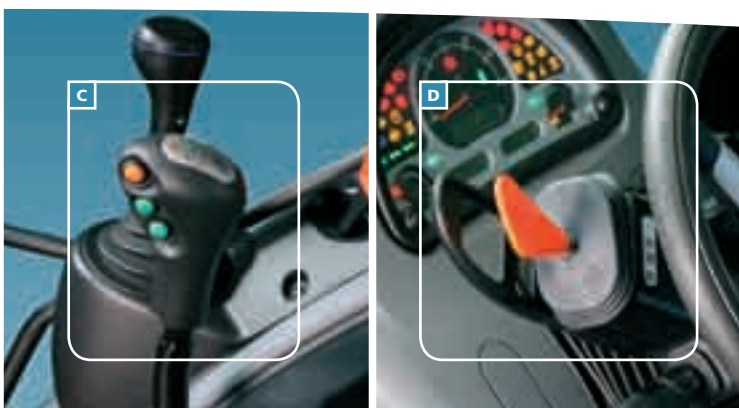
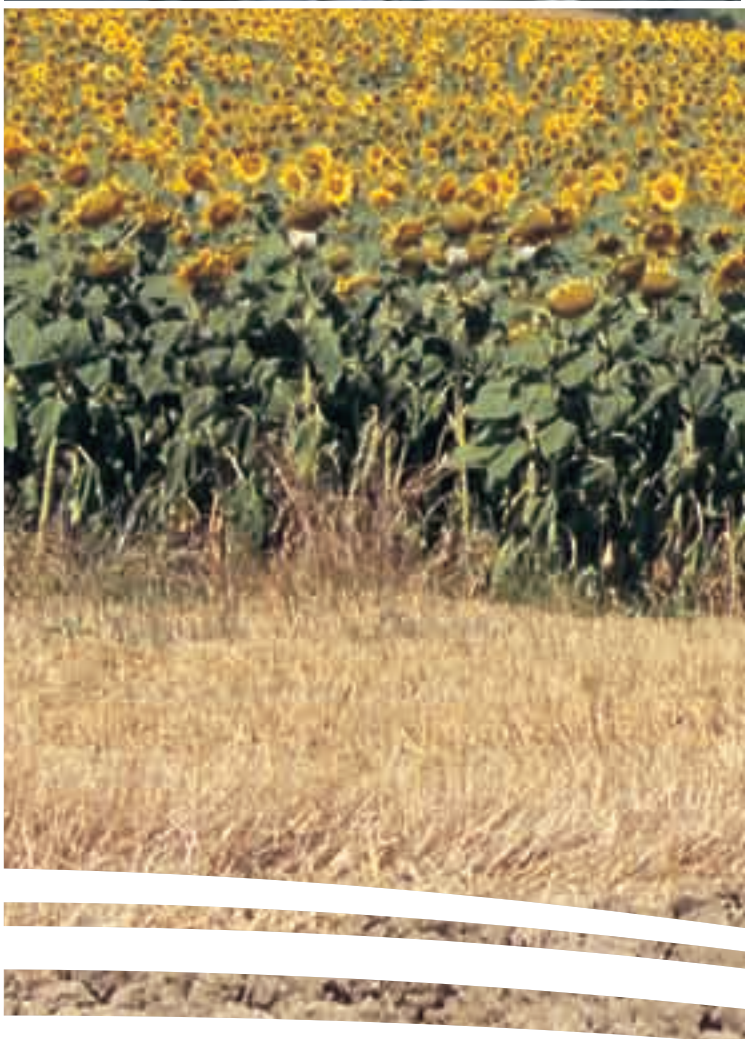



POWERMONDIAL: PERFORMANCE, VERS



**NEW LANDTECH
POWER LIFT**

WITH ERGONOMY
THE STYLISH RIGHT
DRIVER'S RIGHT, THE
INCORPORATES ALL
OFFERING MAXIMUM
OF IMPLEMENTS. >
THE CAT. 2 THREE-
CAPACITY OF 4700

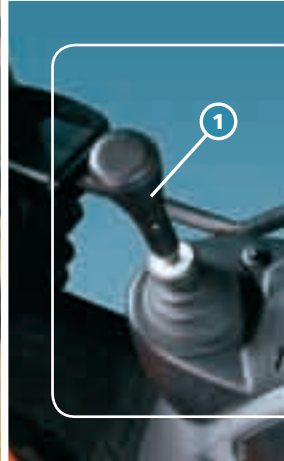

**"MASTER CLASS"
COMFORT AND**

THE "MASTER CLASS"
FULL-SIZED, REAR-H
ALL-ROUND VISIBIL
ENTER AND EXIT WI
THE QUALITY AND
ARRANGED CONTR
PROOFING MAXIMIS
AN ATHERMIC GLA
LOADER OPERATION
EQUIPPED WITH PNE
STEERING WHEEL A
SYSTEM, THE CAB C
LONG HOURS IN TH
EIGHT POWERFUL
VISIBILITY DURING M

SATILITY AND STYLISH DESIGN

RONIC ELECTRONIC

ICALLY-ARRANGED CONTROLS ON
T-HAND CONSOLE LOCATED TO THE
E LANDTRONIC ELECTRONIC POWER LIFT
MAIN FUNCTIONS AND REGULATIONS
M COMFORT AND FINGERTIP CONTROL
FIG. E

POINT HITCH (FIG. F) PROVIDES A LIFT
KG.

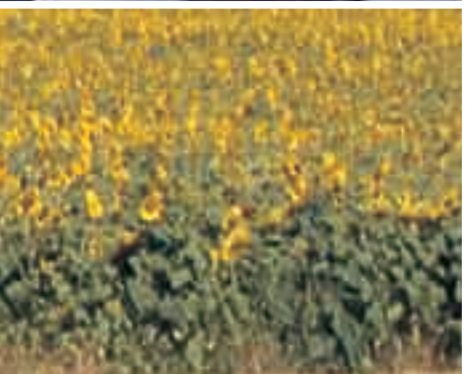
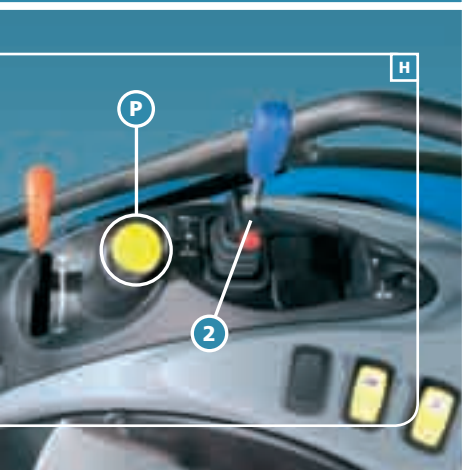
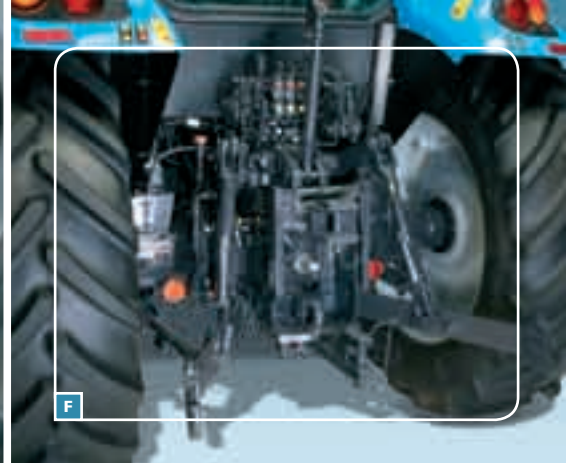

HYDRA-PTO: 2- OR 3-SPEED PTO WITH HYDRAULIC ENGAGEMENT FOR MAXIMUM FLEXIBILITY

THE 1 3/8-INCH PTO WITH HYDRAULIC ENGAGEMENT OFFERS TWO BASIC SPEEDS OF 540/750 OR 540/1000 RPM. AN ADDITIONAL 3-SPEED PTO PROVIDING 540/750/1000 RPM IS AVAILABLE AS AN OPTION FOR INCREASED VERSATILITY.

THE 120 MODEL IS EQUIPPED WITH DUAL POWER WHICH UTILISES THE ELECTRONIC CONTROL OF THE ENGINE. THIS SYSTEM IS DESIGNED TO AUTOMATICALLY INCREASE BY 10 HP THE POWER AND TORQUE AVAILABLE WHEN THE PTO IS OPERATING UNDER LOAD IN DIFFICULT WORKING CONDITIONS, THEREBY ENHANCING THE TRACTOR PERFORMANCE AND PRODUCTIVITY.

THE WET DISC CLUTCH, OPERATED BY PUSH BUTTON (P), ENABLES SMOOTH AND PROGRESSIVE ENGAGEMENT OF THE PTO, PREVENTING ABRUPT STARTING OF THE SHAFT FOR ADDED OPERATOR COMFORT AND IMPLEMENT DRIVE LINE PROTECTION. > FIG. H

HIGH-PERFORMANCE HYDRAULICS AND FLEXABILITY OF REMOTE VALVES

THE NEW HYDRAULIC SYSTEM PROVIDES A MAXIMUM TOTAL FLOW OF 90 L/MIN (FOR MODEL 120).

THE SYSTEM FEATURES UP TO FIVE REMOTE VALVES WITH LEVER CONTROLS INTEGRATED IN THE CONSOLE TO THE DRIVER'S RIGHT. > FIG. H

TWO OF THE REMOTE VALVES ARE CONTROLLED BY JOYSTICK (1) FOR FRONT LOADER OPERATIONS, WHILE THE OTHER THREE ARE OPERATED BY STANDARD LEVERS (2) GIVING THE POWERMONDIAL EXTRA VERSATILITY AND PRODUCTIVITY.

"CLASS" CAB FOR SUPERIOR AND VISIBILITY

"CLASS" CAB HAS A FOUR-POST DESIGN WITH
HINGED DOORS WHICH PROVIDE TOTAL
ITY AND ALLOW THE OPERATOR TO
TH EASE.

DO DESIGN OF THE ERGONOMICALLY-
ROLS AND THE EXCELLENT SOUND-
SE THE OPERATOR COMFORT.

ASS SLIDING SUNROOF MAKES FRONT
S EASIER.

OMATIC SUSPENSION SEAT, ADJUSTABLE
AND AN EFFICIENT CLIMATE CONTROL
REATES THE IDEAL ENVIRONMENT FOR
E FIELD.

HALOGEN LIGHTS PROVIDE GREATER
NIGHT WORK. > FIG. I

